

HELIX T0100 REGULAR
FD165 (1)

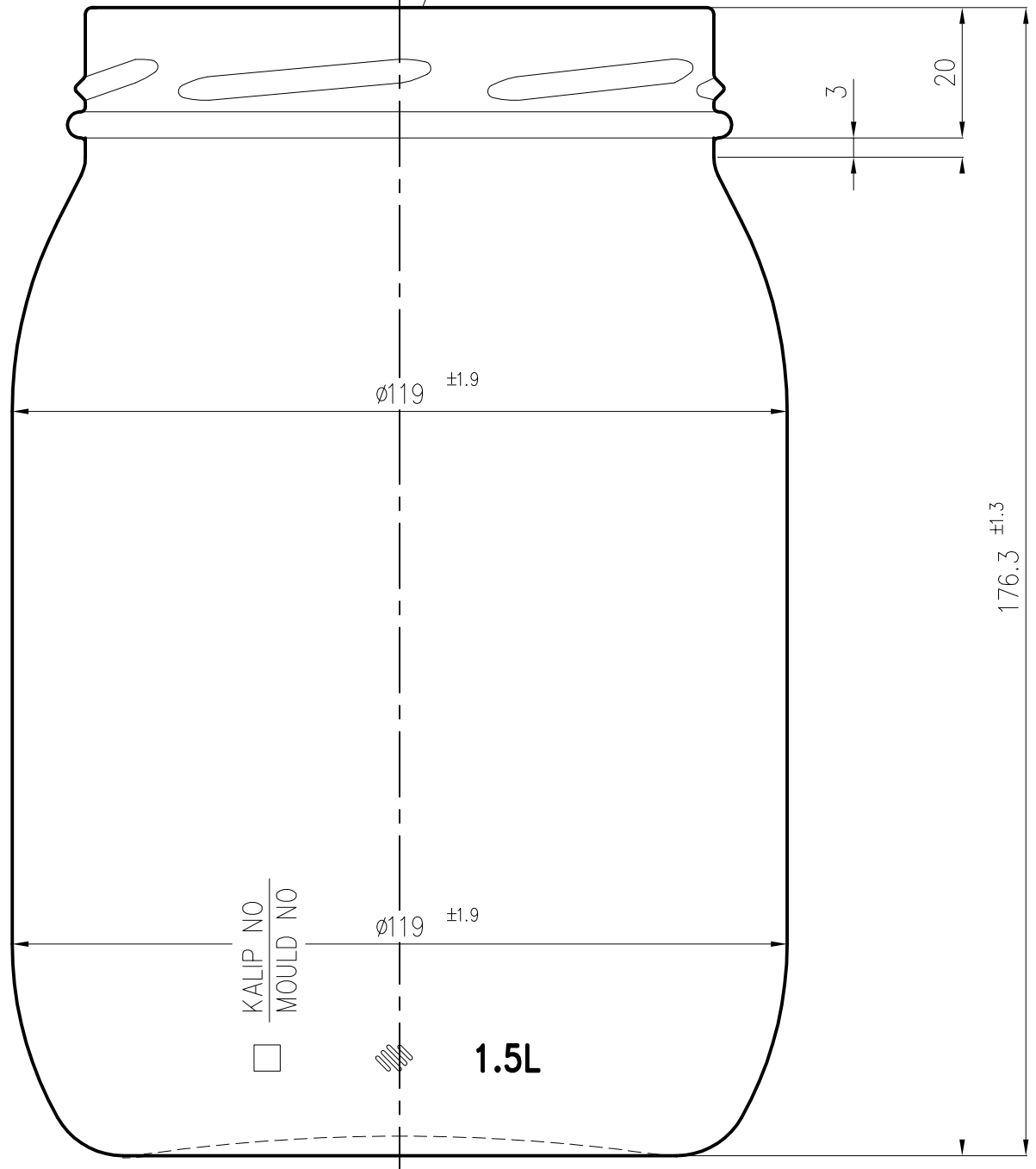

Anadolu Cam Sanayii A.Ş.
Ürün Tasarım Müdürlüğü
tarafından çizilmiştir
15.09.2011

